

292800E

292900E

293000E

293100E

293200E

293300E

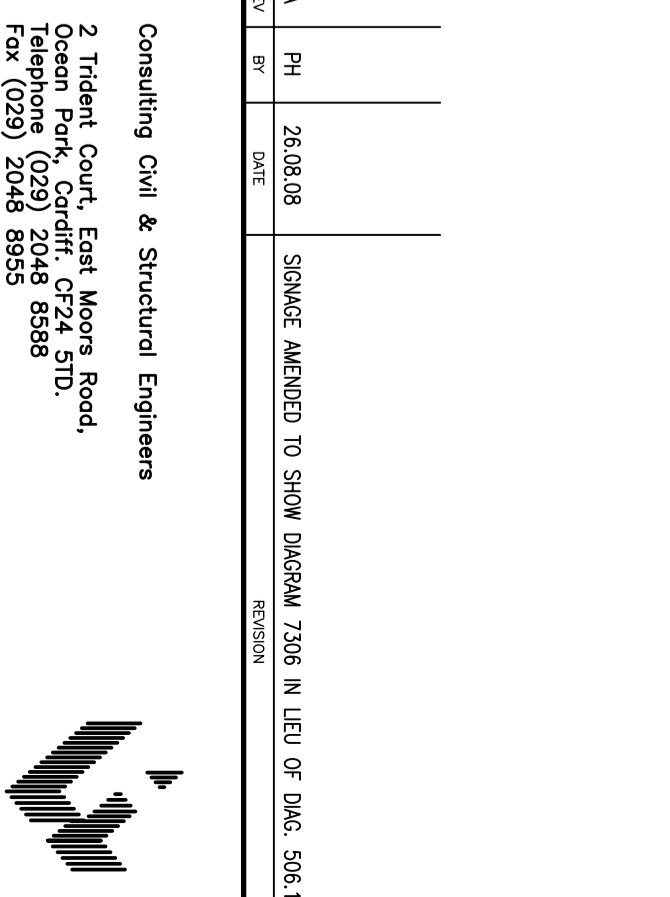
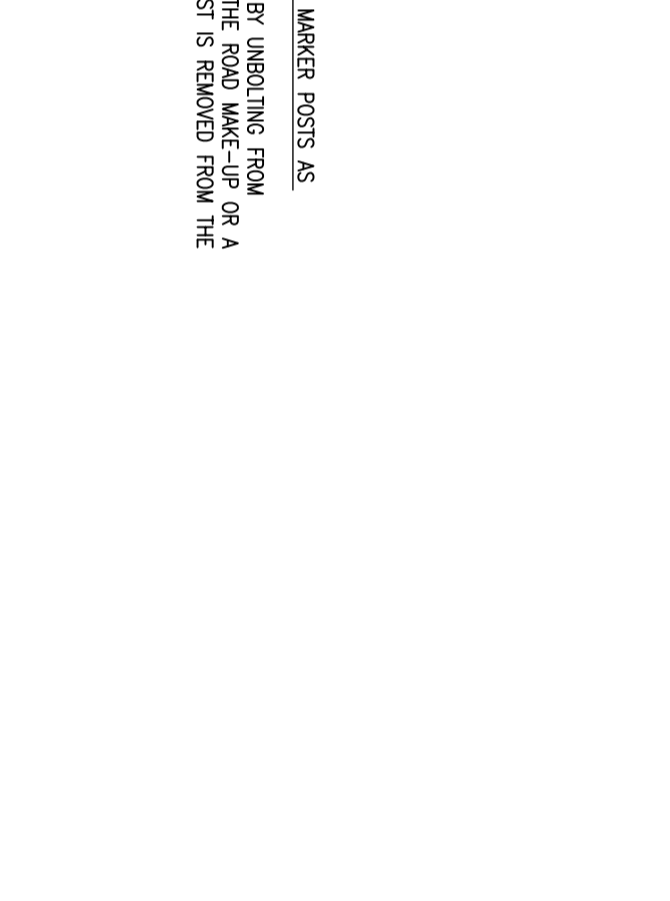
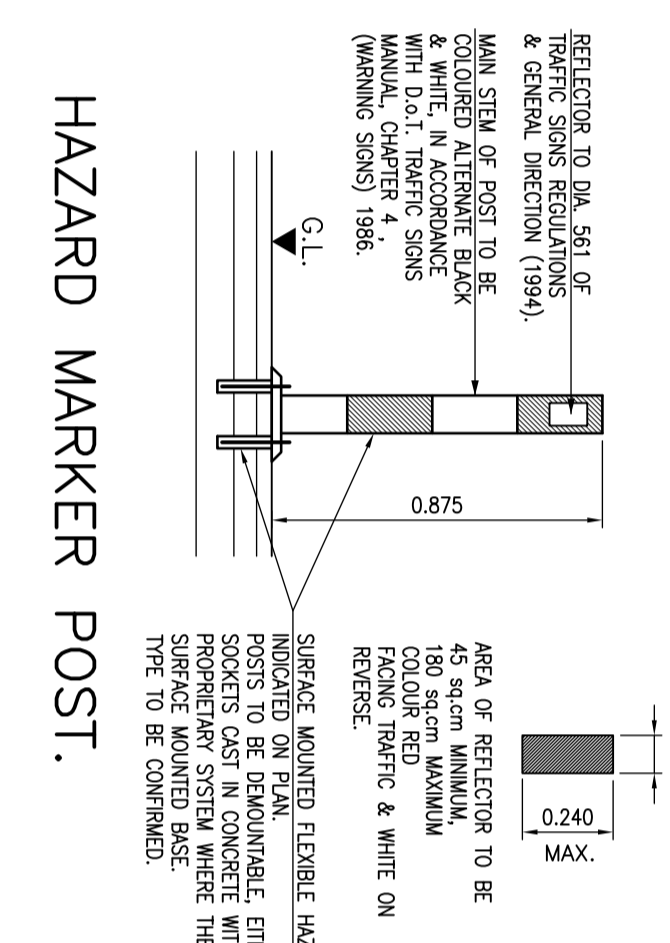
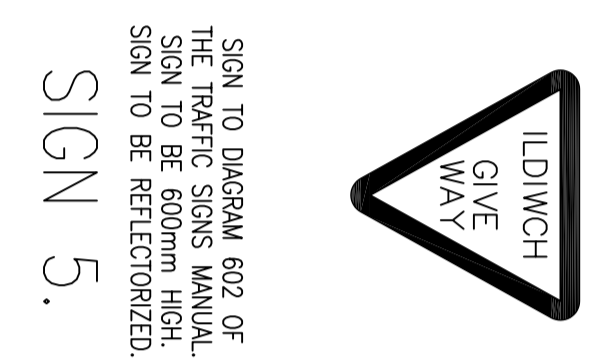
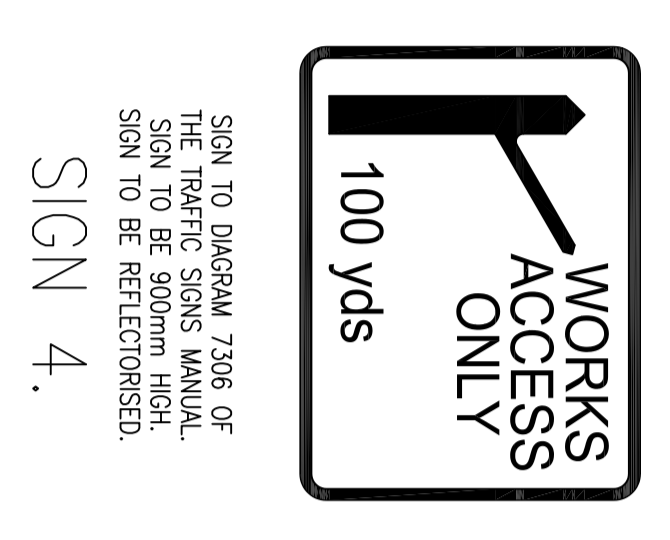
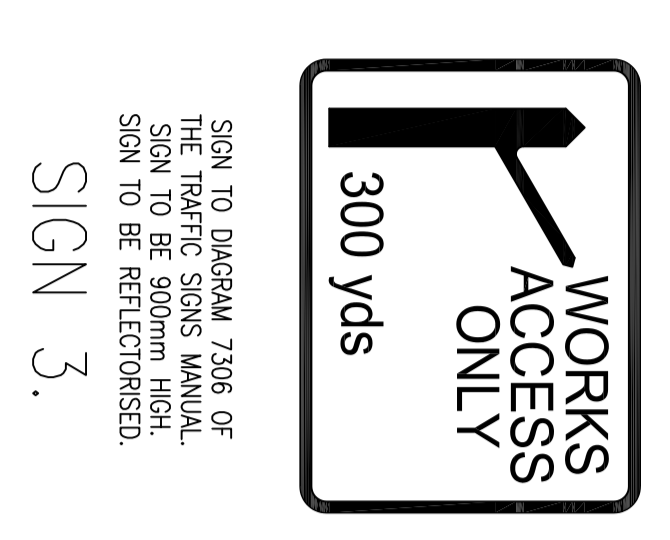
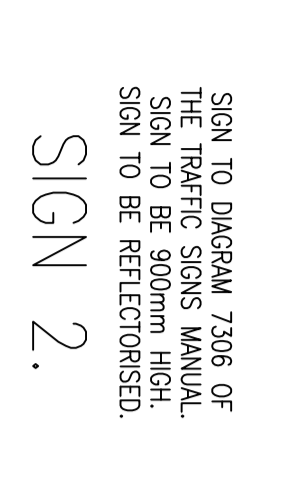
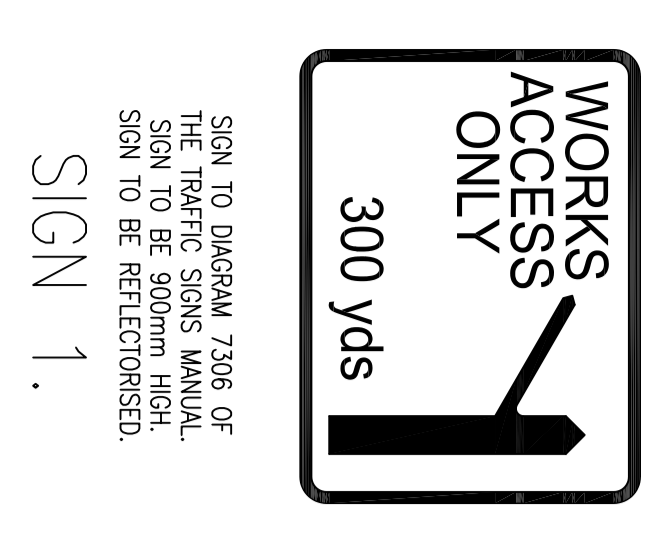
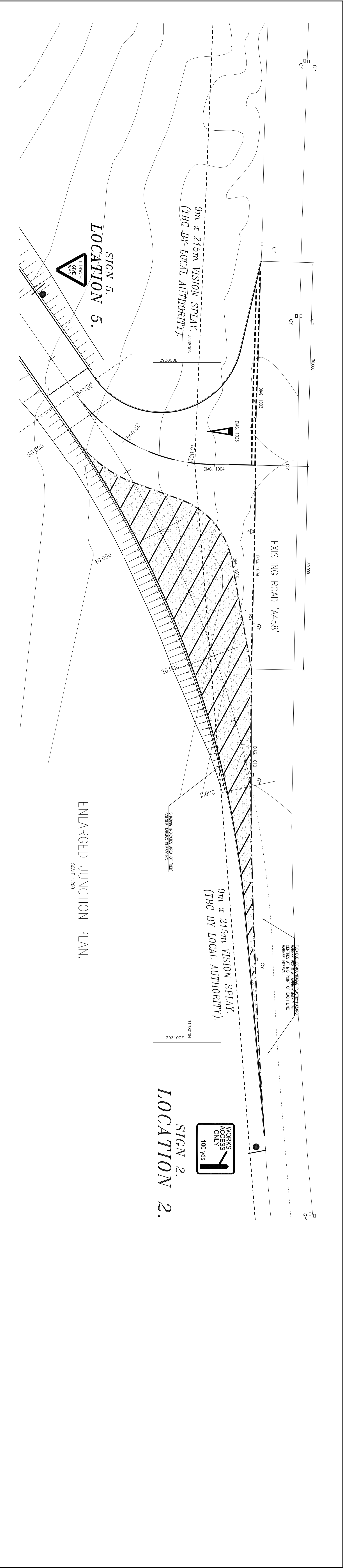
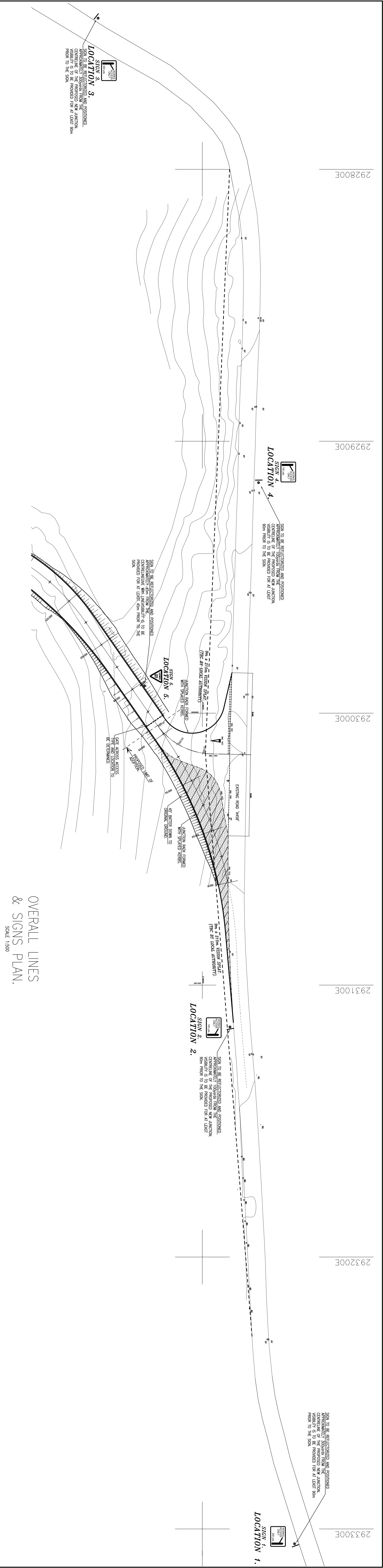

PROJECT TITLE		CARRIBO MEN WIND FARM	
LINES & SIGNS DETAILS FOR MAIN JUNCTION.			
CONSULTING CIVIL & STRUCTURAL ENGINEERS BRINDHAM HILL CONSULTING CIVIL & STRUCTURAL ENGINEERS 3 Station Road, Eastleigh, Hampshire, SO50 9JG Tel: (0703) 5244 8855 Fax: (0703) 5244 8855			
DATE	15.08.2018	SCALE	AS SHOWN
DESIGNED BY	PH	CHECKED BY	PH
DATE	26.08.08	SCALE	AS SHOWN
PROJECT NO.	6009/003	REVISION	A
STATUS	PRELIMINARY	REGISTERED IN ENGINEER	MEMBER NO. 524320